

LABELMATE

The World's Leading Manufacturer of Label
Rewinders, Unwinders, Dispensers, Slitters
& Core Chucks

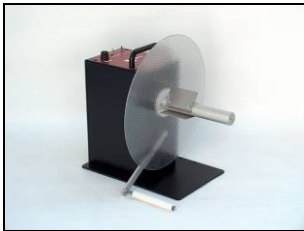
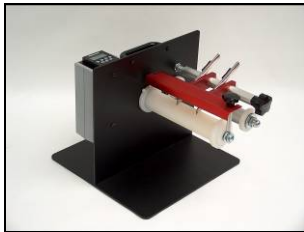
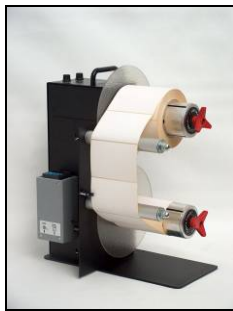
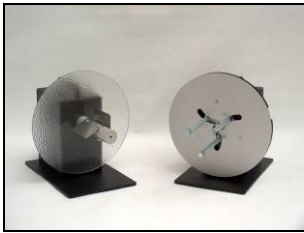
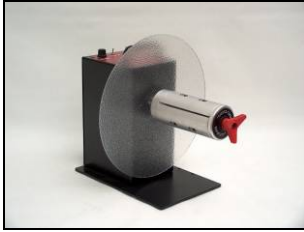
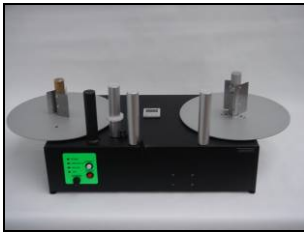

Product Catalogue and Price List

September 2009

- DISPENSERS
- REWINDERS
- UNWIND/REWIND STATIONS
- UNWINDERS *New Models!*
- SLITTERS
- SLITTING STATIONS
- COUNTING SYSTEMS
- PRINTER MECHANISM
- CORE CHUCKS

LABELMATE EUROPE, 69 AVENUE ALPHONSE XIII,
1180 BRUSSELS – BELGIUM

T: +32 2 375 69 60 F: +32 2 375 38 96

E-mail: brussels@labelmate.com www.labelmate.com

LABELMATE USA, HENDERSON, NEVADA, USA

LABELMATE

End user Price – 09/2009 v1.0

The World's Leading Manufacturer of Label Rewinders, Unwinders, Dispensers, Slitters and Core Chucks featuring Constant Adjustable Torque ('CAT') Technology.

LABEL DISPENSERS

CHOOSING THE RIGHT DISPENSER	2
"LD & LD-RS" POWERED LABEL DISPENSERS	3

LABEL REWINDERS

CHOOSING THE RIGHT REWINDER	6
FULL SIZE "CAT" HEAVY-DUTY LABEL REWINDERS	7
LOW-COST "MINI-CAT" LABEL REWINDERS	10
"TWIN-CAT-2" DUAL SPINDLE UNWIND / REWIND STATIONS.....	12

LABEL UNWINDERS

CHOOSING THE RIGHT UNWINDER	15
"LC-CAT" PAPER LOOP CONTROLLED LABEL UNWINDERS	18
"UCAT" HEAVY-DUTY LABEL UNWINDERS	20

"QUICK-CHUCKS"™

QUICK-LOADING CORE CHUCKS FOR VOLUME LABEL PRODUCTION	23
---	----

LABEL SLITTERS & SLITTING STATIONS

HEAVY-DUTY LABEL SLITTERS & SLITTING STATIONS	24
"SP" LABEL SEPARATOR PLATES FOR SLITTERS	27

LABEL COUNTERS & COUNTING SYSTEMS

"RRC" REEL-TO-REEL COUNTING SYSTEM	28
"COUNT" HEAVY-DUTY LABEL COUNTERS.....	30

LABEL PRINTER MECHANISM

"PM-300" REEL-TO-REEL LABEL PRINTER MECHANISM FOR INKJET HEADS	31
--	----

- All products are manufactured to LABELMATE's World-Class Quality Standards and are maintenance-free.
- The proven high-reliability of our Products has lead us to increase our famous warranty on all Rewinders and Unwinders to an unmatched **5-Year Parts and Labour Limited Warranty**, five times the industry norm! All other LABELMATE Products are still backed by our renowned **full 3-Year Parts and Labour Limited Warranty**. (The Warranty Period for included Power Supplies, Counter Modules and Encoders is 1-Year.)
- Units returned for repair or exchange must have a RMA form.
- Product Data Sheets are available on-line 24-hours a day at www.labelmate.com.
- If you don't see what you want please ask us. Many special configurations are available (120-vac 60 Hz models: same price).
- A 25€ fee will be charged for re-packaging costs in case of returned units due to a mistake in the order.

Prices are in Euros, Ex-Works shipping point. Prices and specifications are subject to change without notice.

Previous price lists are obsolete.

PRICES DO NOT INCLUDE DELIVERY COSTS.

Shipping is done with UPS Standard Service unless specified otherwise in the order.

CHOOSING THE RIGHT DISPENSER

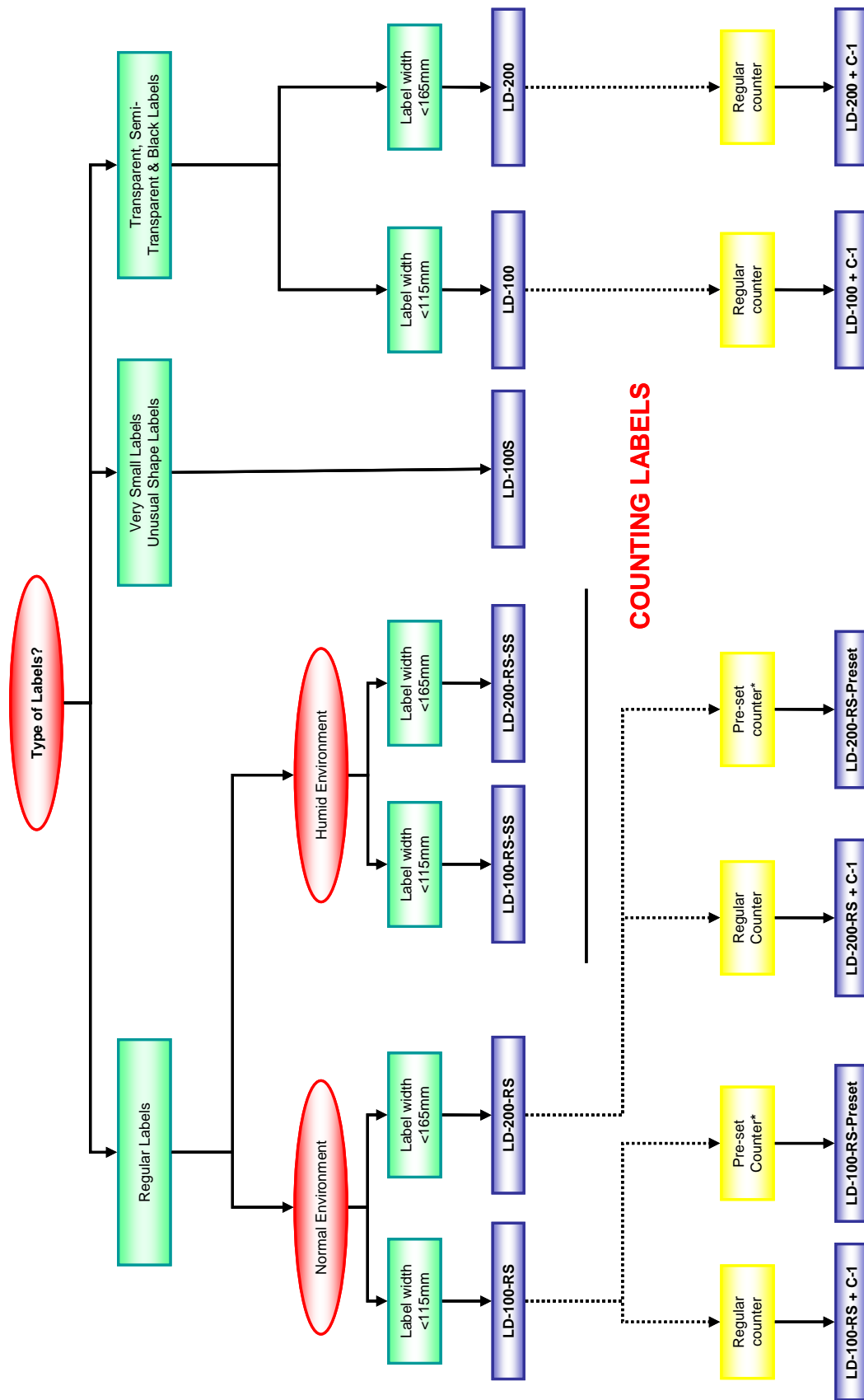

*The Pre-set counter stops the dispenser when pre-set count is reached.

“LD & LD-RS” POWERED LABEL DISPENSERS

The LD-RS Type Automatic Label Dispensers with enhanced label sensing and easy set-up.

The **LD-100-RS** and **LD-200-RS** Label Dispensers advance the state of the art with new convenience and durability. Using the latest opto-electronic technology, there is just one simple adjustment for label length. A special Reflective Sensor sits below the label and reliably and accurately senses the leading edge of your label. As you pick up a label the next one is automatically and instantly advanced. The modern design presents the label right at the front of the machine, providing optimum convenience for both left-handed and right-handed operators. A “HIGH-LOW” Speed Switch allows adjustment for label length or operator preference. There are no mechanical position switches to cause adjustment or operational problems. The heavy-duty product design will stand up to the most demanding environments.

The **LD-100-RS-SS** and **LD-200-RS-SS** feature a stainless steel chassis and cover and can be used in humid environment. They are ideal for food industry and pharmaceutical applications.

The **LD-100-RS-Preset** and **LD-200-RS-Preset** are equipped with a pre-set counter that will stop the Label Dispenser after the pre-set count is reached.

The LD-100 and LD-200 for transparent labels!

You can choose the **LD-100** or **LD-200** that automatically advances your next label and presents it for instant picking. Using the latest technology, these useful Label Dispensers work with nearly any kind of label: black, semi-transparent and even completely **transparent**. The **LD-100** and **LD-200** have an adjustable infra-red-Optical Switch that senses the beginning of the next label and stops the label advance. A “HIGH-LOW” Speed Switch plus an adjustable sensor allow you to set up the Dispenser for various length labels and to compensate for labels that may have a tendency to curl up.

The LD-100S and LD-200S for very small, long or unusual shape labels.

The **LD-100S** or **LD-200S** continually advances labels at the rate you choose. The **LD-100S** and **LD-200S** also include an ON-OFF Foot Switch for production applications. It is ideal for very small or long labels.

All LABELMATE Label Dispensers are easy to set up, too. You just slide your roll of labels onto the built-in Core Holder. Then thread the label web through to the take-up spindle and your Label Dispenser is ready for use! Rugged, heavy-gauge steel construction and precision parts yield products of the highest quality. Designed for all-day, every-day use, these Dispensers are backed by LABELMATE’s famous **3-Year Parts and Labour Limited Warranty**, assuring you trouble-free performance.



LD-100-RS



LD-100



LD-100S

September 2009

www.labelmate.com

brussels@labelmate.com

• POWERED LABEL DISPENSERS •

MODEL	DESCRIPTION	LABEL WIDTH (mm)	LABEL LENGTH (mm)	ROLL DIAM. (mm)	SPEED (mm/sec)
LD-100-RS	Automatically advances the next label ready to pick. Fast label loading. Quick and convenient operation! Not for transparent labels.	Up to 115	6 to 150*	220	110 Minimum
LD-200-RS	Same features as LD-100-RS but with wider label capacity.	Up to 165	6 to 150*	220	110 Minimum
LD-100-RS-SS	Same features as LD-100-RS but in stainless steel.	Up to 115	6 to 150*	220	110 Minimum
LD-200-RS-SS	Same features as LD-200-RS but in stainless steel.	Up to 165	6 to 150*	220	110 Minimum
LD-100-RS Preset	Same features as LD-100-RS but with pre-set counter.	Up to 115	6 to 150*	220	110 Minimum
LD-200-RS Preset	Same features as LD-200-RS but with pre-set counter.	Up to 165	6 to 150*	220	110 Minimum
LD-100	Automatically advances the next label ready to pick. Fast label loading. Quick and convenient operation! For transparent and opaque labels.	Up to 115	12 to 150*	220	110 Minimum
LD-200	Same features as LD-100 but with wider label capacity.	Up to 165	12 to 150*	220	110 Minimum
LD-100S	Label Dispenser with variable speed control and foot switch. Ideal for very small or long labels.	Up to 115	5 to unlim.	220	110 Minimum
LD-200S	Same features as LD-100S but with wider label capacity.	Up to 165	5 to unlim.	220	110 Minimum

* Depending on the labels.

MAXIMUM LABEL ROLL WEIGHT: 4.5Kg.

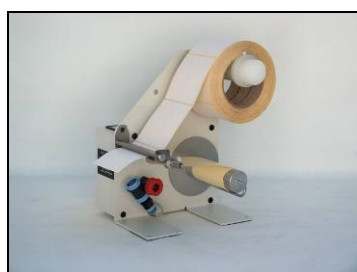

LD-100-RS with Counter



LD-100-RS-SS

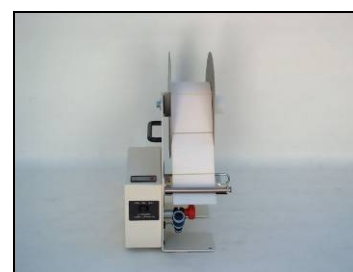

LD-100-RS with Flanges and Counter

September 2009

www.labelmate.com

brussels@labelmate.com

• POWERED LABEL DISPENSERS •

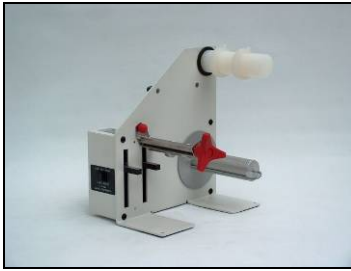

LD-100



LD-100-RS-Preset

LABEL DISPENSERS OPTIONS

MODEL	DESCRIPTION	ROLL DIAM. (mm)	SPEED (mm/sec)
C-1	Counter option for Label Dispenser LD-100-RS, LD-200-RS, LD-100 & LD-200 (factory installed).	-	-
LD-FLANGES-220	Inner and outer Flange option for Label Dispenser (per pair). Fits all models. Recommended for narrow labels.	220	-
LD-FLANGES-300	Inner and outer Flange option for Label Dispenser (per pair). Fits all models. <u>To be used with LD-DE.</u> Recommended for narrow labels.	300	-
LD-DE	Diameter extension: Allows using rolls with outer diameters up to 300mm (factory installed).	300	-
PS-11V	230V – 50Hz AC Power Supply for LD. Output: 11V – 2.5A. Included with the LD.	-	-
PS-18V	High-speed power supply to increase speed of the dispenser.	-	140
EXT. COMMAND	The LD dispenses one label when receives a signal (contact closure). Factory installed. Only for LD-RS models.	-	-

Choosing the right Rewinder

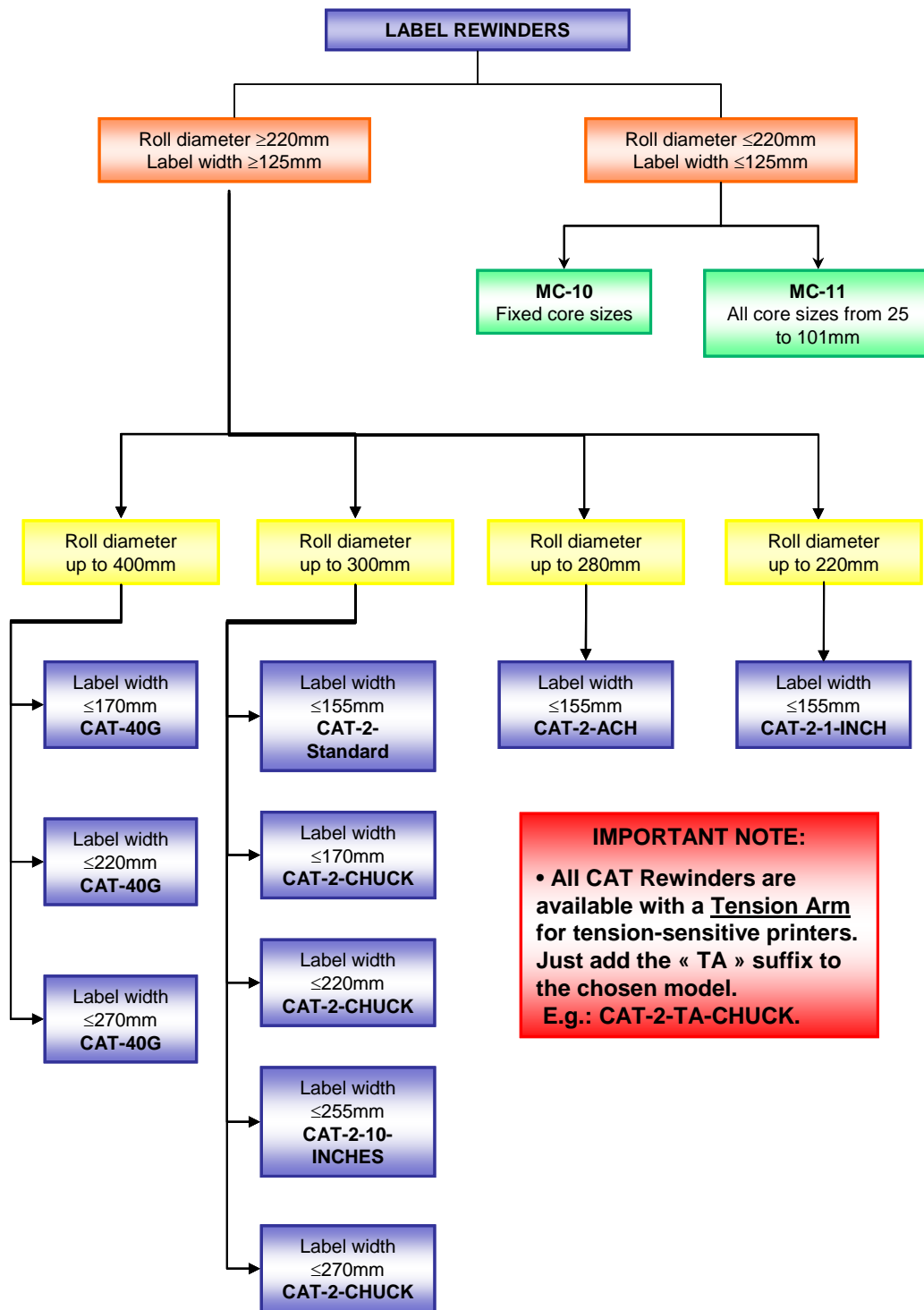

OTHER IMPORTANT INFORMATION:

1. The **CAT-2-ACH** has an Adjustable Core Holder that accepts all core sizes from 25 to 101mm.
2. The Quick-Chuck used on the **CAT-40G** is available in 3 different lengths: 170, 220 and 270mm.
3. The **CAT-2-Standard**, **CAT-2-10-INCHES** and **CAT-2-CHUCK** are available in various core sizes: 38, 40, 44, 70 and 76mm (the Quick-Chuck is also available in 100mm core size).
4. The **CAT-2-1-INCH** is used for core diameter of 1" (25,4mm).

Full Size "CAT" Heavy-Duty Label Rewinders

The CAT-2 Heavy-Duty Label Rewinders

LABELMATE's **Constant Adjustable Torque™** ("CAT") technology has made the silent, easy-to-use **CAT-2** the "**Industry Standard**" Label Rewinder. There are no awkward troublesome belts or clutches.

The **CAT-2-STANDARD** handles labels up to 155 mm (6-inches) wide and will wind a roll of labels up to 300 mm (12") diameter. Torque and Direction are fully controllable from the Control Panel. Dual torque ranges provide plenty of power for use with a LABELMATE Slitter, too.

For wider labels up to 255 mm (10"), choose the **CAT-2-10"**.

Model **CAT-2-ACH** includes an Adjustable Core Holder that accepts any core size from 25 mm to 101 mm (1-inch to 4-inches) in diameter and up to 155 mm (6-inches) in width.

The optional Adjustable Paper Guide **APG-CAT** with movable arm can be installed in minutes on the base plate of the **CAT-2-ACH** or **CHUCK**. This inexpensive accessory guides the outer edge of the label roll as it's being rewound to ensure even roll alignment.

The **CAT-2-CHUCK** includes LABELMATE's durable "Quick-Chuck"™ quick-locking Core Chuck, permitting the fastest loading and unloading of cores and label rolls. The **CAT-2-CHUCK** is ideal for label slitting applications, high-volume production environments, or anywhere the ultimate convenience in Rewinders is desired. The **CAT-2-CHUCK** is available for 38-,40-,44-,70, 76- and 100 mm cores.

The **CAT-40G** is gear motor driven for more torque. It accepts bigger rolls with a diameter up to 400 mm. It is equipped with the LABELMATE "Quick-Chuck"™ quick-locking Core Chuck.

Please note that if to be placed after a printer, you need the CAT-40G-TA.

The CAT-2-TA Heavy-Duty Label Rewinders

The **CAT-2-TA** is a **CAT-2** with a tension arm specially engineered for applications that require fixed web tension. The TA is available for all models of **CAT-2**. **All CAT-2-TA's are supplied with a Heavy-Duty Power Supply.**

IMPORTANT NOTE: The **CAT-2-TA** can be also be used as a regular **CAT-2** with the same features.

Rugged, heavy-gauge steel construction allows your **CAT-2 / CAT-2-TA** Rewinder to be simply set in place. Special anti-slip feet keep the unit from moving. The **CAT-2** handles any rewind job and with its "HIGH" torque range can also power the LABELMATE **S-100** or **S-200** Label Slitters.

Reliable, high quality and maintenance-free, the Heavy-Duty **CAT-2 / CAT-2-TA** Label Rewinders feature a **5-Year Parts and Labour Limited Warranty**, the longest in the industry. Put LABELMATE **CAT-2 / CAT-2-TA** Label Rewinders to work for you today and enjoy a new dimension in label rewinding convenience and reliability. Custom colours, badging, and special core holders are available for private label applications.

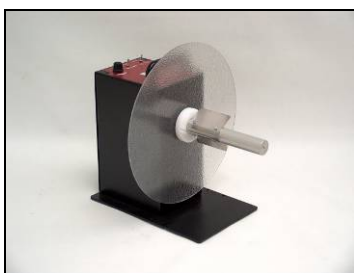

CAT-2-STANDARD

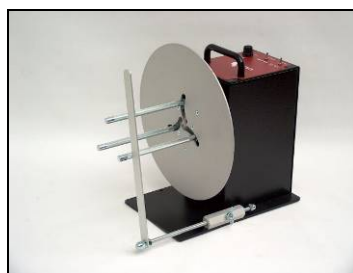

CAT-2-ACH with APG-CAT



CAT-2-TA-CHUCK

September 2009

www.labelmate.com

brussels@labelmate.com

• FULL SIZE "CAT-2" & "CAT-2-TA" HEAVY-DUTY LABEL REWINDERS •

Note: All Rewinders can be used as Unwinders

MODEL	ADD SUFFIX	DESCRIPTION	LABEL WIDTH (mm)	ROLL DIAM. (mm)	SPEED* (mm/sec)
CAT-2	STANDARD	The 'Industry Standard' Heavy-duty Label Rewinder. 76mm standard; 38, 40, 44, 70 mm on request.	155	300	1250
	ACH	CAT-2 with an Adjustable Core Holder for any core size from 25 to 101mm in diameter. With inner flange. Use APG-CAT if you wish to also guide the outer edge of your label.	155	280	1250
	CHUCK	The industry standard Heavy-duty Label Rewinder with an easy-loading 'Quick-Chuck'. Ideal for production work. 76mm standard. See page 23 for other available 'Quick-Chuck' sizes.	170	300	1250
	10-INCHES	CAT-2 for labels up to 255mm wide. 76mm standard; 38, 40, 44 or 70mm on request.	255	300	1250
	1-INCH	CAT-2 for 25.4mm diameter cores.	155	220	1250
CAT-40G	-	Gear motor driven. Tight rewind up to 400mm. 76mm 'Quick-Chuck' standard. See page 23 for other available 'Quick-Chuck' sizes.	170	400	320

CAT-2-TA	STANDARD	Same features as CAT-2-STANDARD but with Tension Arm.	155	300	1250
	ACH	Same features as CAT-2-ACH but with Tension Arm.	155	280	1250
	CHUCK	Same features as CAT-2-CHUCK but with Tension Arm.	170	300	1250
	10-INCHES	Same features as CAT-2-10-INCHES but with Tension Arm.	255	300	1250
	1-INCH	Same features as CAT-2-1-INCH but with Tension Arm.	155	220	1250
CAT-40G-TA	-	Same features as CAT-40G but with Tension Arm.	170	400	320

* SPEED: The indicated speeds are the maximum speeds at beginning of a 76mm core roll.

NOTE: A Second flange is included with all models except ACH and CHUCKS.

MAXIMUM LABEL ROLL WEIGHT:

STANDARD: 7Kg.

ACH: 6Kg.

10-INCHES: 8Kg.

CHUCK: 15Kg.

CAT-40G: 12Kg.

• FULL SIZE "CAT-2" & "CAT-2-TA" HEAVY-DUTY LABEL REWINDERS •

Note: All Rewinders can be used as Unwinders



CAT-2-10-INCHES

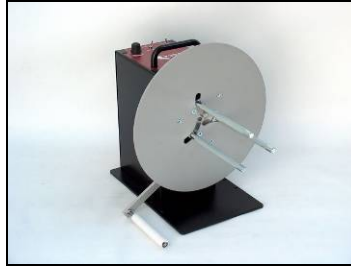

CAT-2-TA-ACH



CAT-40G-TA

LABEL REWINDERS CAT-2 / CAT-2-TA OPTIONS

MODEL	DESCRIPTION	LABEL WIDTH (mm)
APG-CAT	Optional Adjustable Paper Guide For CAT-2(-TA)-ACH or CAT-2(-TA)-CHUCK. Guides the outer edge of the label web to ensure an even roll edge.	-
FLANGE - CAT	Flange for CAT-2-STANDARD and CAT-2-10-INCHES. <i>Specify if internal or external.</i>	-
STANDARD SHAFT	Standard shaft for CAT-2 with vanes, internal and external flanges.	155
10" SHAFT	10-Inches shaft for CAT-2 with vanes, internal and external flanges.	255
VANES	Set of 3 vanes (fins). 38, 40, 44, 70 & 76mm available	-
ACH-CAT	Adjustable Core Holder for any core size from 25 to 101mm in diameter. With inner flange.	155
LTO	Low Torque Option. For tension sensitive printers. Factory installed.	-
FOOT SWITCH	Foot Switch to start and stop the TWIN-CAT-2, CAT-2 or MC Rewinders (€80 for the MC).	-
PS-11V	230V - 50Hz AC Power Supply for CAT-2 and UCAT-2. Output: 11V – 2.5A. Included with CAT-2 Rewinder.	-
PS-15V	230V – 50Hz DC Heavy-Duty Power Supply. Output: 15V – 4.6A. Included with CAT-2-TA Rewinder.	-
PS-24V	Power supply for CAT-40G, S-100SP and RRC. Output: 24V – 4.17A. Included with CAT-40G and CAT-40G-TA Rewinders.	-

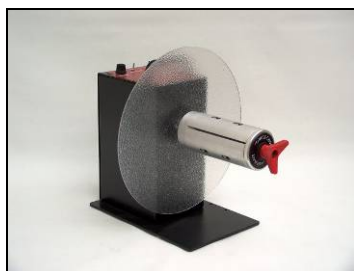

CAT-2-10-CHUCK

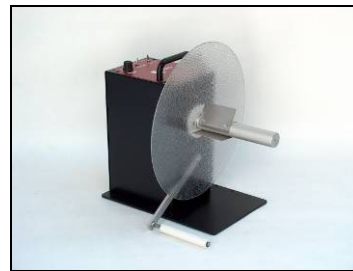

CAT-2-TA-STANDARD

September 2009

www.labelmate.com

brussels@labelmate.com

Low-Cost “Mini-CAT” Label Rewinders

The MINI-CAT's are now equipped with a direction switch, allowing you to easily change the direction.

The MINI-CAT (MC) Label Rewinders are the world's most popular low-price Label Rewinders. They are capable of rewinding label rolls up to 125mm (5 ") wide (115 mm or 4½ -inches for MC-11), up to 220 mm (8.6") in diameter at speeds up to 50 cm/sec (20-ips).

The MINI-CATs can also be used as Label Unwinders.

The **MC-10** has a 76 mm (3") diameter vane style core holder. You can also use the included “coreless rewind” feature to rewind directly on-shaft.

The **MC-11** includes a precision-crafted Adjustable Core Holder that adjusts in seconds to accept any core diameter from 25- to 101-mm (1" to 4").

Both MINI-CATs use LABELMATE's proprietary Constant Adjustable Torque™ (“CAT”) technology to achieve impressive, reliable performance at an unprecedented low price. A special motor, designed specifically for the MINI-CATs, offers bi-directional operation and trouble-free performance. A switch conveniently controls the amount of rewind force. No awkward, troublesome belts or clutches are used and no speed adjustments are required. Your MINI-CAT automatically adjusts to any printer speed up to 50cm/sec and even allows label back-feeding automatically, if your printer requires it.

The MINI-CATs have an inner label flange to keep the edge of the label web aligned as the labels are being rewound. Also available is an optional Adjustable Paper Guide (**APG-MC**) that mounts directly to the **MC-10** or **MC-11** base plate and guides the outer edge of the labels. For the **MC-10**, an optional plastic Outer Flange (**2ndFlange MC-10**) is also available.

Rugged steel construction allows your MINI-CAT to simply be set in place near your label printer. Special anti-slip feet keep the unit from moving. Put a LABELMATE MINI-CAT to work for you today and enjoy a new dimension in label rewinding convenience and reliability. The MINI-CAT features a **5-Year Parts and Labour Limited Warranty**, the longest in the industry.



MC-10

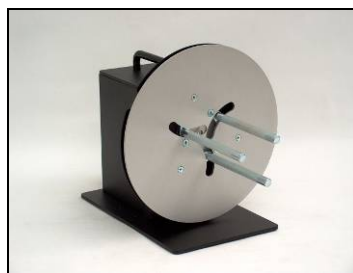

MC-11

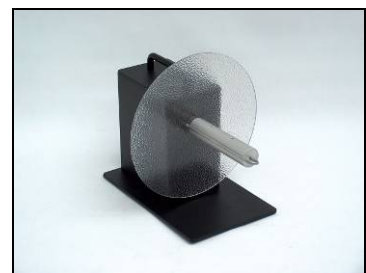

MC-10 with Bail

• LOW-COST "MINI-CAT" LABEL REWINDERS •

Note: All Rewinders can be used as Unwinders

MODEL	DESCRIPTION	LABEL WIDTH (mm)	ROLL DIAM. (mm)	SPEED* (mm/sec)
MC-10	Quality, low-cost Rewinder & Unwinder, coreless or 76mm standard. 38, 40, 44 or 70mm core rewinding on request. Bi-directional with multiple rewind / unwind force settings.	125	220	500
MC-10 -1 INCH	Same as above but with a 25,4mm core.	125	220	500
MC-11	Same as MINI-CAT-10 but with continuously Adjustable Core Holder for 25 to 101mm diameter cores.	115	220	500

* SPEED: The indicated speeds are the maximum speeds at beginning of a 76mm core roll.

MAXIMUM LABEL ROLL WEIGHT: 3Kg.

LABEL REWINDERS MC-10 / MC-11 OPTIONS

MODEL	DESCRIPTION	LABEL WIDTH (mm)
FLANGE MC-10	Flange for MC-10 only. <i>Specify if internal or external.</i>	-
APG-MC	Adjustable Paper Guide for MC-11. Guides outer edge of label to ensure an even roll edge.	Same as Rewinder
VANES	Set of 3 vanes (fins). 38, 40, 44, 70 & 76mm available	-
BAIL	Standard on MC-10. For rewind on shaft, no core is needed.	Same as Rewinder
ACH-MC	Adjustable Core Holder for any core size from 25 to 101mm in diameter. With inner flange.	115
LTO	Low Torque Option. For tension sensitive printers. (Inkjet). Factory installed.	-
FOOT SWITCH	Foot Switch to start and stop the MC Rewinders. MC to be modified at factory.	-
PS-MC	230V - 50Hz Power Supply for MC-10 and MC-11. Included with Rewinder.	-

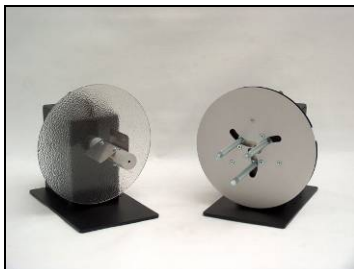

MC-10 & MC-11

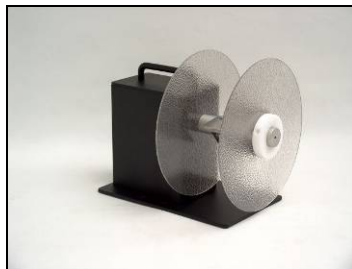

MC-10 with 2nd flange



MC-11 with APG-MC

September 2009

www.labelmate.com

brussels@labelmate.com

"TWIN-CAT-2" Dual Spindle Unwind / Rewind Stations

Here's LABELMATE's Dual-Spindle Heavy Duty Unwinder / Rewinder, the TWIN-CAT-2. With two powerful motors and your choice of core holders you have maximum versatility in setting up the operation you need. Both spindles can rewind or unwind. You control the direction and torque on each Spindle independently. An External Halt Control allows you to STOP and START the TWIN-CAT-2 with a foot switch or other external device if desired. A worldwide universal switching power supply is included for extra power.

Here are some of the many possible applications:

- Unwind and Rewind labels on one machine. Ideal for "wind-in / wind-out" operations.
- Reverse the order of serialized labels on a roll.
- Conveniently rewind labels onto a different core size. With universal Adjustable Core Holders you can unwind from any diameter core and rewind onto any diameter core within the range of 25 to 101mm in diameter! Great for production shops with varied jobs.
- Add the Label Inspection option to create a stand-alone Inspection Station. You can also add a Label Counter if you need one.
- Wind small rolls of labels from larger ones.
- Conveniently strip the unwanted matrix from die-cut labels for easy disposal as you rewind them in-line with your printer or off-line.

LABELMATE's Unwind / Rewind Stations are available in many different configurations to fit perfectly into your label production. All TWIN-CAT-2 Models operate at up to 125cm per second.

The TWIN-CAT features a **5-Year Parts and Labour Limited Warranty**, the longest in the industry.



TWIN-CAT-2 ACH

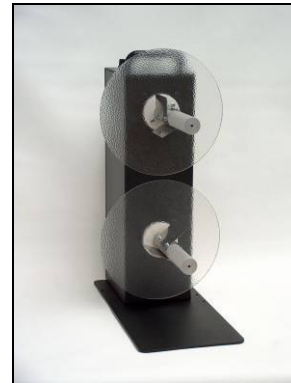

TWIN-CAT-2 STANDARD

• "TWIN-CAT-2" Dual Spindle Unwind / Rewind Station •

TWIN-CAT-2 Base unit (no core holder)	ADD TWO CORE HOLDERS FROM LIST (MIX OR MATCH)	CORE DIAMETER	WIDTH	NUMBER OF FLANGES
	1-INCH	25,4 mm (1")	155 mm	1
	STANDARD	Specify 38, 40, 44, 70 or 76 mm	155 mm	2
	10-INCH	Specify 38, 40, 44, 70 or 76 mm	255 mm	2
	ACH-TWIN (No Mix*)	25 to 101 mm	155 mm	1
	CHUCK – C-xx*170	*Specify 38, 40, 44, 70 or 76 mm	170 mm	1
	CHUCK – C-76220	76 mm	220 mm	1
	CHUCK – C-76270	76 mm	270 mm	1
	CHUCK – C-100170	100 mm	170 mm	1
	CHUCK – C-100220	100 mm	220 mm	1
	CHUCK – C-100270	100 mm	270 mm	1

* The ACH-TWIN core holders can not be mixed with another type.

MAXIMUM LABEL ROLL WEIGHT: 2 x 5Kg.

Each spindle allows rolls up to 220 mm (8.6") in diameter.

How to Specify Your TWIN-CAT-2 Stand-alone Unwind / Rewind Station – Refer to the above.

“TWIN-CAT-2, [*specify Core Holder*] Upper Spindle, [*specify Core Holder*] Lower Spindle.”
Add Inspection and / or Counter Options if desired. Please see the table next page.



TWIN-CAT-2 Standard / C-76170

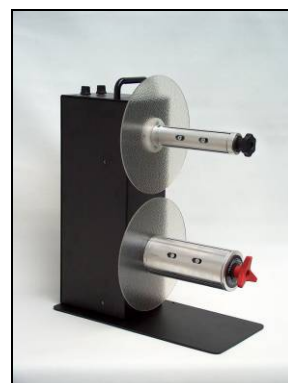

TWIN-CAT-2 C-40170 / C-76170

September 2009

www.labelmate.com

brussels@labelmate.com

• "TWIN-CAT-2" Dual Spindle Unwind / Rewind Station •

TWIN-CAT-2 LABEL INSPECTION AND COUNTER OPTIONS

The Label Inspection option, **INSP-1**, adds a handy Label Inspection Fixture to the side of your **TWIN-CAT-2**. It has two rollers over which your labels run as they are presented for inspection. You can also wind-in or wind-out at the same time as you perform the inspection operation. If you want to, when inspection is complete, you can conveniently rewind the labels back onto their original core one the same machine by just reversing the direction of the Rewind Spindles.

You can also order a **PC-1** Label Counter for your inspection station. This will count the labels as they pass by a sensor mounted on the Inspection Fixture. The **PC-1** counts single- or multi-across labels and you can preset a batch size. Counts up. Includes a Halt Control Cable to optionally stop your **TWIN-CAT-2** automatically when your job is finished.

MODEL	DESCRIPTION
INSP-1	Inspection Fixture mounts in minutes on the side of your TWIN-CAT-2. Includes two rollers that your labels glide over as they are presented for inspection. Bi-directional, variable speed operation allows control over winding tightness as well. Can be started and stopped with the optional Foot Switch listed below.
INSP-1 + PC-1	Optional Preset Counter with adjustable counter sensitivity. Conveniently pre-mounted on the INSP-1 Inspection Fixture ready to plug in and use.
FOOT SWITCH	Foot Switch to start and stop the TWIN-CAT-2, CAT-2 or MC Rewinders (€80 for the MC).
OUTER FLANGE TWIN QC	220mm outer Flange for "Quick-Chuck" 76mm core diameter.
PS-15V	230V – 50Hz DC Heavy-Duty Power Supply. Output: 15V – 4.6A. Included with TWIN-CAT-2.



TWIN-CAT-2 with INSP-1 & PC-1

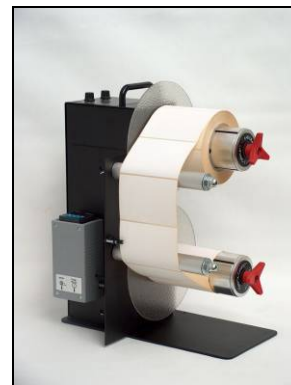

TWIN-CAT-2 C-76170 / C-76170 with INSP-1 & PC-1

Choosing the right Unwinder

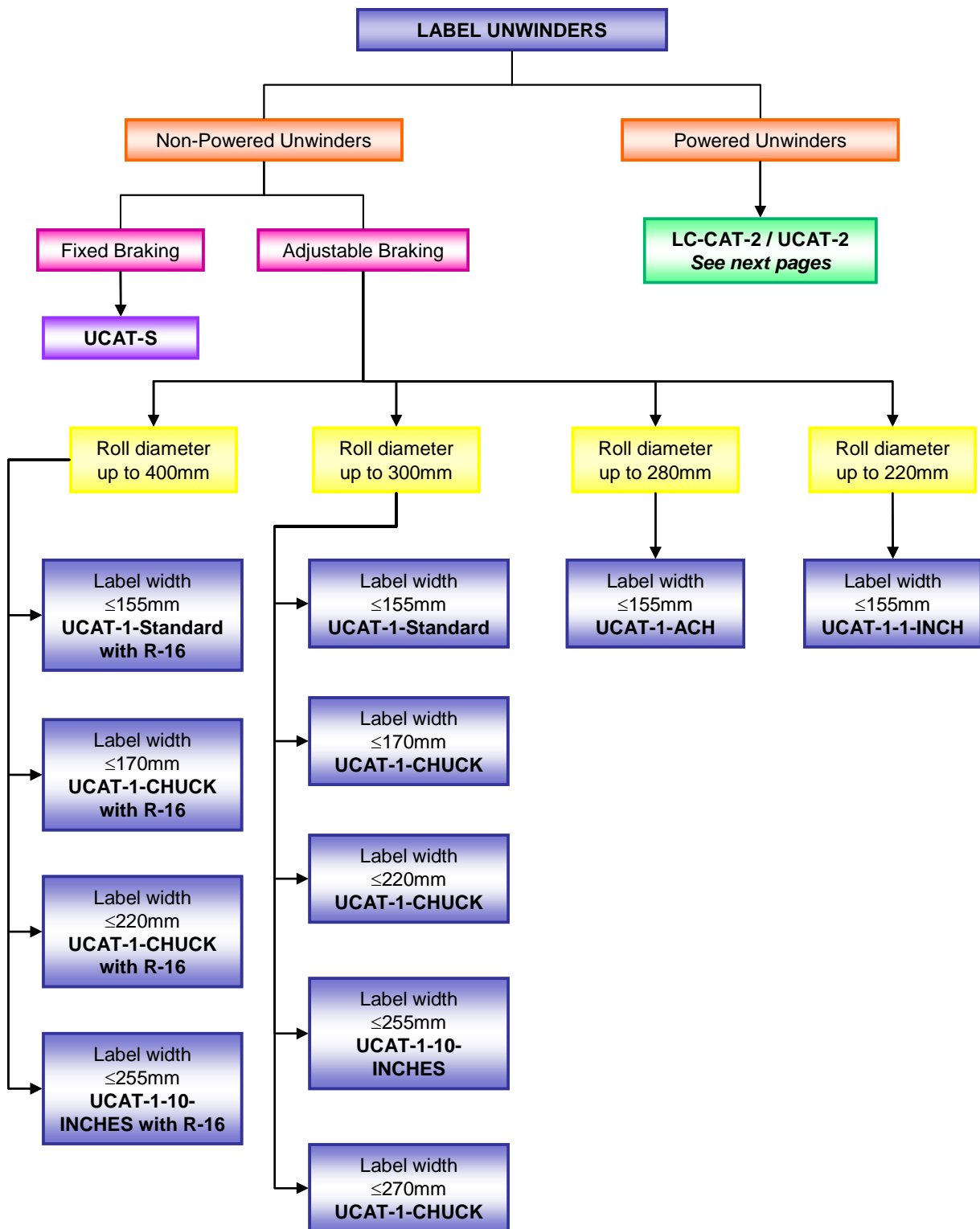

OTHER IMPORTANT INFORMATION:

1. The **UCAT-1-ACH** has an Adjustable Core Holder that accepts all core sizes from 25 to 101mm.
2. The **UCAT-2-Standard**, **UCAT-1-10-INCHES** and **UCAT-1-CHUCK** are available in various core sizes: 38, 40, 44, 70 and 76mm (the Quick-Chuck is also available in 100mm core size).
3. The **UCAT-1-1-INCH** is used for core diameter of 1" (25,4mm).

September 2009

www.labelmate.com

brussels@labelmate.com

Choosing the right Unwinder (Cont.)

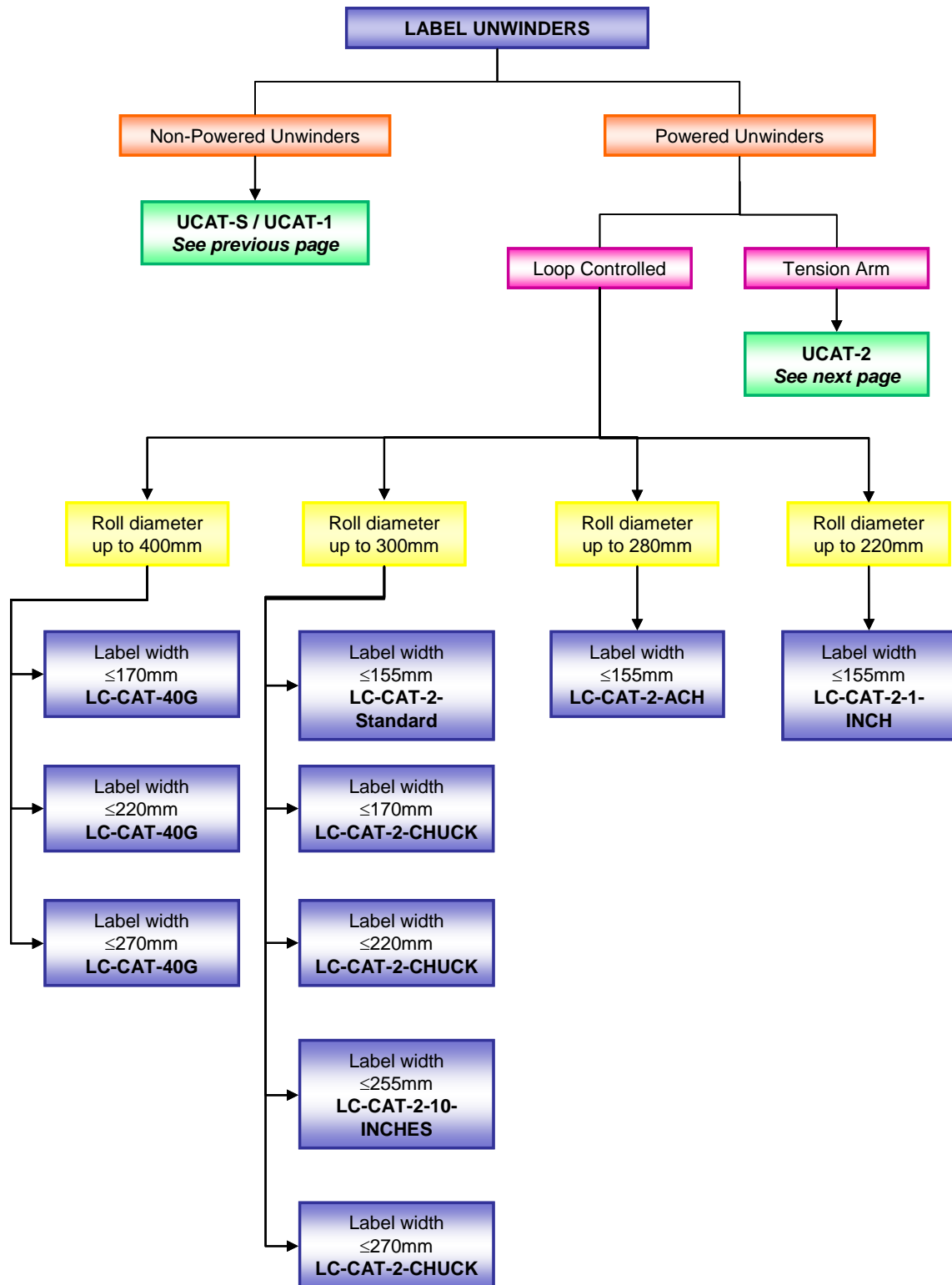

OTHER IMPORTANT INFORMATION:

1. The **LC-CAT-2-ACH** has an Adjustable Core Holder that accepts all core sizes from 25 to 101mm.
2. The Quick-Chuck used on the **LC-CAT-40G** is available in 3 different lengths: 170, 220 and 270mm.
3. The **LC-CAT-2-Standard**, **LC-CAT-2-10-INCHES** and **LC-CAT-2-CHUCK** are available in various core sizes: 38, 40, 44, 70 and 76mm (the Quick-Chuck is also available in 100mm core size).
4. The **LC-CAT-2-1-INCH** is used for core diameter of 1" (25,4mm).

September 2009

www.labelmate.com

brussels@labelmate.com

Choosing the right Unwinder (Cont.)

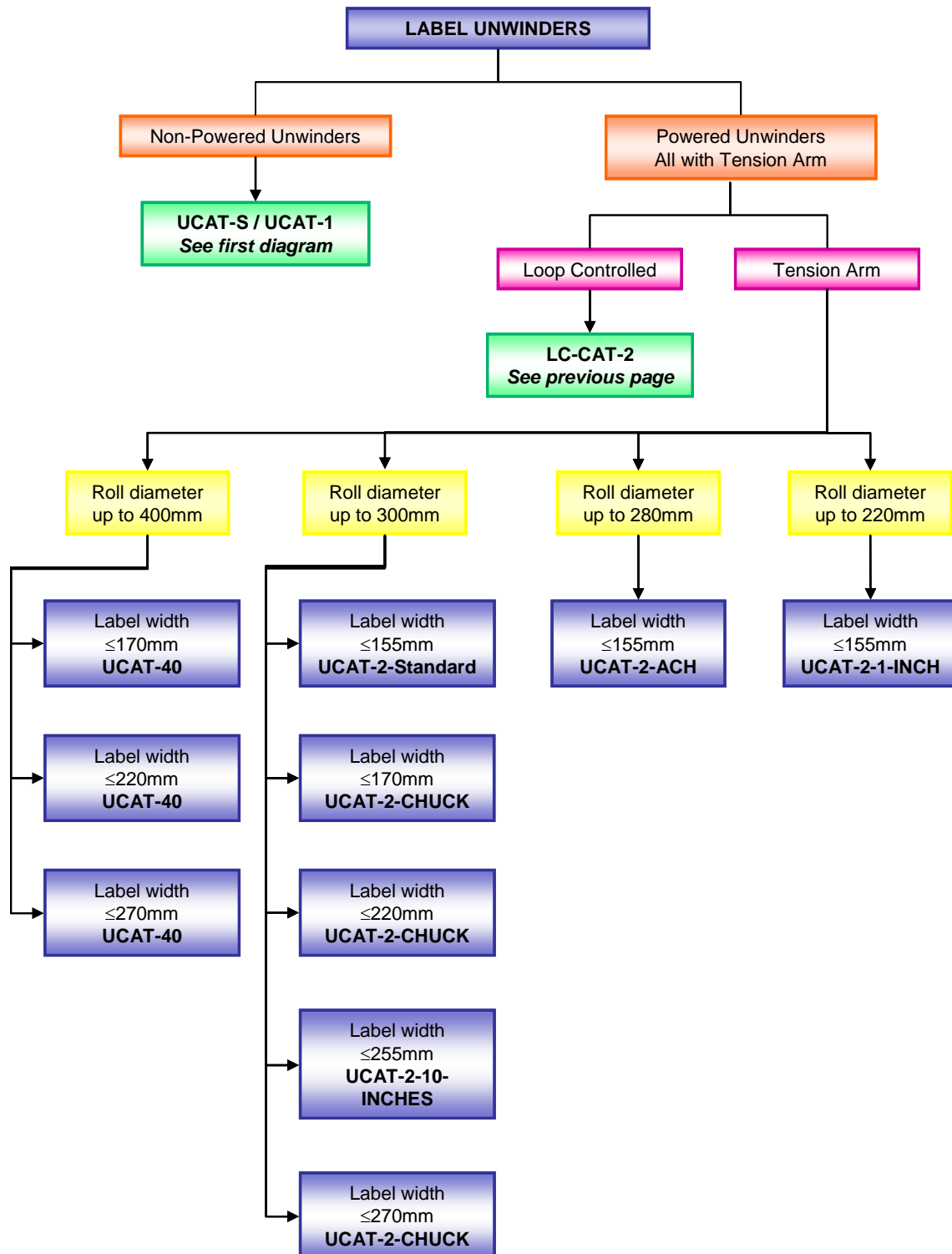

OTHER IMPORTANT INFORMATION:

1. The **UCAT-2-ACH** has an Adjustable Core Holder that accepts all core sizes from 25 to 101mm.
2. The Quick-Chuck used on the **UCAT-40** is available in 3 different lengths: 170, 220 and 270mm.
3. The **UCAT-2-Standard**, **UCAT-2-10-INCHES** and **UCAT-2-CHUCK** are available in various core sizes: 38, 40, 44, 70 and 76mm (the Quick-Chuck is also available in 100mm core size).
4. The **UCAT-2-1-INCH** is used for core diameter of 1" (25,4mm).

September 2009

www.labelmate.com

brussels@labelmate.com

“LC-CAT” Paper Loop Controlled Label Unwinders

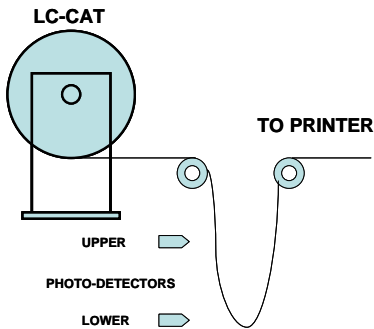

The new LC-CATs, primarily developed for unwinding, can also be used to rewind. The unwind function is controlled using two photo-detectors positioned along the paper loop formed between the Unwinder and the printer.

This approach reduces the paper resistance to the printer to almost zero and offers a far greater reliability than tension-arm systems.

All models use 2 visible light photo-detectors that connect to the rear panel of the machine. The cables are 2 meters long. The detection range is adjustable from 20 to 400mm.

The **LC-CAT-2** will accept rolls up to a 300 mm diameter. The weight of the rolls accepted by the **LC-CAT-2** depends on the chosen core holder.

The **LC-CAT-40G** is using a gear motor and will accept rolls up to 400 mm diameter. Because of the roll size accepted, the **LC-CAT-40G** is only available with the LABELMATE's durable "Quick-Chuck"[™] quick-locking Core Chuck, permitting the fastest loading and unloading of cores and label rolls.

The **LC-CAT-40G** is available for 38-, 40-, 44-, 70, 76- and 100 mm cores.

Torque and Direction are fully controllable from the Control Panel. All models are bi-directional. All LC-CATs are supplied with the adequate power supply.

Rugged, heavy-gauge steel construction allows your **LC-CATs** Unwinders/Rewinders to be simply set in place. Special anti-slip feet keep the unit from moving. Reliable, high quality and maintenance-free, the **LC-CATs** Unwinders/Rewinders feature a **5-Year Parts and Labor Limited Warranty**, the longest in the industry.



LC-CAT-2-CHUCK



LC-CAT-40G

• "LC-CAT" PAPER LOOP CONTROLLED LABEL UNWINDERS •

MODEL	ADD SUFFIX	DESCRIPTION	LABEL WIDTH (mm)	ROLL DIAM. (mm)	SPEED* (mm/sec)
LC-CAT-2	STANDARD	Equipped with a Standard Core Holder. 76mm standard; 38, 40, 44, 70mm on request.	155	300	1250
	ACH	LC-CAT-2 with an Adjustable Core Holder for any core size from 25 to 101mm in diameter. With inner flange. Use APG-CAT if you wish to also guide the outer edge of your label.	155	280	1250
	CHUCK	Equipped with an easy-loading 'Quick-Chuck'. Ideal for production work. 76mm standard. See page 23 for other available 'Quick-Chuck' sizes.	170	300	1250
	10-INCHES	LC-CAT-2 for labels up to 255mm wide. 76mm standard; 38, 40, 44 or 70mm on request.	255	300	1250
	1-INCH	LC-CAT-2 for 25.4mm diameter cores.	155	220	1250
LC-CAT-40G	-	Gear motor driven. Rolls up to 400mm. 76mm 'Quick-Chuck' standard. See page 23 for other available 'Quick-Chuck' sizes.	170	400	320

* SPEED: The indicated speeds are the maximum speeds at beginning of a 76mm core roll.

MAXIMUM LABEL ROLL WEIGHT:

STANDARD: 7Kg.

10-INCHES: 8Kg.

ACH: 6Kg.

CHUCK: 15Kg.

LC-CAT-40G: 15Kg.

LC-CAT-2 OPTIONS

MODEL	DESCRIPTION
APG-CAT	Optional Adjustable Paper Guide For LC-CAT-2-ACH. Guides the outer edge of the label web to ensure an even roll edge.
PS-15V	230V – 50Hz DC Heavy-Duty Power Supply. Output: 15V – 4.6A. Included with LC-CAT-2.
PS-24V	230V - 50Hz AC Power Supply. Output: 24V – 4.17A. Included with LC-CAT-40G.

“UCAT” Heavy-Duty Label Unwinders

The UCAT-1 Heavy-Duty Unpowered Label Unwinders

A label Unwinder is what you need to manage your label supply rolls. From very inexpensive to very sophisticated, LABELMATE’s family of Heavy-Duty “UCAT” Label Unwinders will keep your label production running smoothly. All LABELMATE Unwinders are bi-directional.

UCAT-S: This is the world’s least expensive professional Unwinder. It is unpowered and has a trouble-free fixed brake. The UCAT-S accepts up to 300 mm (12”) diameter rolls and up to 155 mm (6”) width, 76mm (3”) cores.

UCAT-1: This is the classic LABELMATE Unwinder with Adjustable Speed-Proportional Braking. Up to 300 mm (12”) diameter rolls and 155 mm (6”) width, 76mm (3”) cores. Optional 255 mm (10”) width and a 25 mm to 101 mm (1” to 4”) Adjustable Core Holder are available. Please see the table of available models next page.

The UCAT-2 & UCAT-40 Heavy-Duty Powered Label Unwinders

UCAT-2: This powered Unwinder automatically tracks label usage and provides powered label feed at speeds up to 125cm /sec. The **UCAT-2** accepts standard 76mm (3”) cores and rolls up to 300 mm (12”) in diameter. 255 mm (10”) width is available. It can also be used as a full-featured Label Rewinder without any special setup. LABELMATE’s renowned Constant Adjustable Torque™ control system allows precise adjustment of feed speeds and rewind torque. External STOP / RUN Input included.

UCAT-40: A powered Unwinder like the UCAT-2, but with an impressive 40 cm (16”) roll diameter capacity. Supplied with LABELMATE’s 76 mm (3” dia. X 6.6” width) “Quick-Chuck”™, the UCAT-40 gives you the ultimate label Unwinder for volume production.

An optional outer Flange is available to guide the outer edge of the label web to ensure an even roll edge.

All UCAT feature a **5-Year Parts and Labour Limited Warranty**, the longest in the industry.

NOTE: UCAT-S & UCAT-1 are unpowered and do not rewind, they only unwind. The UCAT-2 & UCAT-40 are powered and can also rewind.



UCAT-1-Standard

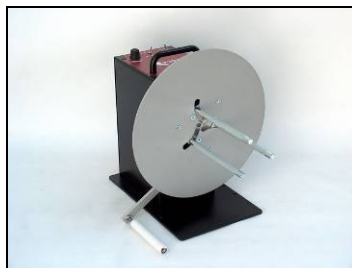

UCAT-2-ACH



UCAT-40

• FULL SIZE "UCAT" HEAVY-DUTY LABEL UNWINDERS •

MODEL	ADD SUFFIX	DESCRIPTION	LABEL WIDTH (mm)	ROLL DIAM. (mm)	SPEED* (mm/sec)
UCAT-S	-	Economy Label Unwinder. Unpowered with fixed brake. 76mm standard; 38, 40, 44 or 70mm on request.	155	300	Same as printer
UCAT-1	STANDARD	Heavy-duty Unwinder 76mm standard. 38, 40, 44 or 70mm on request. Self-powered adjustable Speed-Proportional Frictionless Braking.	155	300	Same as printer
	ACH	UCAT-1 with an Adjustable Core Holder for core sizes from 25 to 101mm diameter cores.	155	280	Same as printer
	CHUCK	UCAT-1 with 76mm 'Quick-Chuck' Core Chuck. See page 23 for other available 'Quick-Chuck' sizes.	170	300	Same as printer
	10-INCHES	UCAT-1 for Labels up to 255mm wide. 76mm standard; 38, 40, 44 or 70mm on request.	255	300	Same as printer
	1-INCH	UCAT-1 for 25,4mm diameter cores.	155	220	Same as printer

UCAT-2	STANDARD	Powered Unwinder for label rolls with 76mm core diameter standard. 38, 40, 44 or 70mm on request. Continuously adjustable feed rate. Control arm tracks label unwind usage and starts & stops unwinding automatically. Also rewinds.	155	300	1250
	ACH	Powered Unwinder with an Adjustable Core Holder for any core size from 25 to 101mm. Also rewinds.	155	280	1250
	CHUCK	UCAT-2 with 76mm 'Quick-Chuck'. Also rewinds. See page 23 for other available 'Quick-Chuck' sizes.	170	300	1250
	10-INCHES	UCAT-2 for Labels up to 255mm wide. 76mm standard; 38, 40, 44 or 70mm on request. Also rewinds.	255	300	1250
	1-INCH	UCAT-2 for 25,4mm diameter cores.	155	220	1250
UCAT-40	-	Heavy-duty 400mm diameter Powered Unwinder with 76mm 'Quick-Chuck'. See page 23 for other available 'Quick-Chuck' sizes. Continuously adjustable feed rate. Control arm tracks label usage and starts & stops unwinding automatically. Also rewinds.	170	400	1250

* SPEED: The indicated speeds are the maximum speeds at beginning of a 76mm core roll.

MAXIMUM LABEL ROLL WEIGHT: STANDARD: 7Kg. – 10-INCHES: 8Kg. - ACH: 6Kg. - CHUCK: 15Kg. - UCAT-40: 12Kg.

• FULL SIZE "UCAT" HEAVY-DUTY LABEL UNWINDERS •

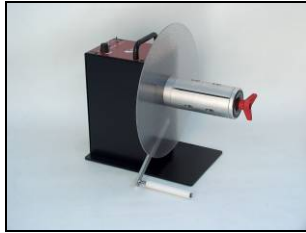

UCAT-2-CHUCK

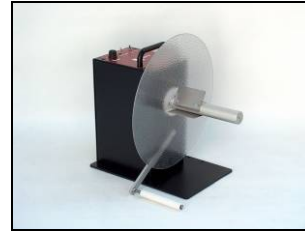

UCAT-2-STANDARD

LABEL UNWINDERS UCAT-1 / UCAT-2 OPTIONS

MODEL	DESCRIPTION	LABEL WIDTH (mm)	ROLL DIAM. (mm)
R-16	Option available on UCAT-1-STANDARD and UCAT-1-CHUCK to accept rolls up to 400mm in diameter. Factory installed.	-	400
APG-UCAT	Optional Adjustable Paper Guide. Guides the outer edge of the label web to ensure an even roll edge.	-	-
ACH-UCAT	Adjustable Core Holder for any core size from 25 to 101mm in diameter. With inner flange.	155	280
STANDARD SHAFT	Standard shaft for UCAT-1 / UCAT-2 with vanes, internal and external flanges.	155	-
10" SHAFT	10-Inches shaft for CAT-2 with vanes, internal and external flanges.	255	-
VANES	Set of 3 vanes (fins). 38, 40, 44, 70 & 76mm available	-	-
PS-11V	230V - 50Hz AC Power Supply for CAT-2 and UCAT-2. Output: 11V – 2.5A. Included with UCAT-2 / UCAT-40 Rewinders.	-	-



UCAT-S

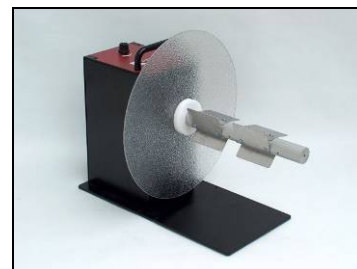

UCAT-1-10-INCHES

“QUICK-CHUCKS”™ Quick-Loading Core Chucks for Volume Label Production

Here is the best answer for quick loading and unloading of label rolls. LABELMATE’s precision, maintenance-free “**Quick-Chuck**”™ Core Chucks permit you to mount or remove a roll of labels on your Rewinder or Unwinder in seconds. They are ideal for heavy rolls, production operations, or for holding multiple cores for slitting. Quality European design and construction insure smooth and trouble-free operation.

To use a **Quick-Chuck**, just slide your label roll over the Chuck and turn the convenient lock knob. Instantly your roll is locked in place. To remove the roll, just give the lock knob a quick turn to the left and pull the roll off your machine!

LABELMATE’s **Quick-Chucks** are now available in six different diameters to accept popular core sizes. An optional Outer Flange is available for the 76 mm (3-inch) “**Quick-Chuck**” Models. An Adjustable Paper Guide (**APG-CAT**) can also be used to guide the outer edge of the label web.

The **UCAT-1-CHUCK**, **UCAT-2-CHUCK** & **UCAT-40** Unwinders and the **CAT-2-CHUCK**, **TWIN-CAT-2**, **CAT-40G**, **CAT-2-TA** & **CAT-40G-TA** Rewinders come equipped with a **Quick-Chuck** as standard. Or, you can buy **Quick-Chucks** individually for your in-house or OEM Applications.

The **Quick-Chucks** fit a 15.75mm diameter shaft.



MODEL	CORE DIAMETER (mm)	MAX. WIDTH (mm)
C-38170	38	170
C-40170	40	170
C-44170	44	170
C70170	70	170
C-76170	76	170
C-76220	76	220
C-76270*	76	270
C-100170	100	170
C-100220	100	220
C-100270*	100	270
300mm inner Flange for “Quick-Chuck” 70 & 76mm core diameter.		
300mm inner Flange for “Quick-Chuck” 38,40 & 44mm core diameter.		
220mm outer Flange for “Quick-Chuck” 76mm core diameter.		
300mm outer Flange for “Quick-Chuck” 76mm core diameter.		
400mm outer Flange for “Quick-Chuck” 76mm core diameter.		

* The C-76270 and C-100270 require the use of a Heavy-Duty Power Supply (PS-15V) on the CAT-2 Rewinder.

September 2009

www.labelmate.com

brussels@labelmate.com

Heavy-Duty Label Slitters & Slitting Stations

The S-100 & S-200 Label Slitters

Here's the most convenient solution for slitting and rewinding narrow labels. LABELMATE Label Slitters allow you to print small labels several across ("up") and then slit them to the desired width. This multiplies your print efficiency by a factor equal to the number of labels across, and dramatically increases your print head life and ribbon usage efficiency. The rugged LABELMATE **S-100** and **S-200** are High-Speed, Heavy-Duty Label Slitters identical in construction except for size.

The Slitters can be used either "in-line" or "off-line". In "in-line" use, the Slitter is placed between the printer output and the Label Rewinder. The slitting speed is determined by the printer output speed. In "off-line" use, the Slitter is placed between a **UCAT** Unwinder and a **CAT-2** Rewinder. Off-line slitting is recommended for production work or for use with three or more blades. With slitting speeds up to 1250mm/sec in "off-line" mode, you'll make fast work of your slitting jobs.

An optional six- (6) digit PC-1 Pre-set Counter allows you to pre-set the number of labels to be slit. When the counter reaches the preset number, it sends a "HALT" signal to the Rewinder. Power to the Rewinder motor is then shut off and braking is applied. You'll have no annoying label spills to contend with.

The S-100-SP Self-Powered Label Slitter

The new **S-100-SP Self-powered Label Slitter** simplifies label slitting by providing powered pinch rollers to pull the labels through the cutting blades rather than having to rely on a Label Rewinder to pull the labels. This results in a constant cutting speed and means you can use any LABELMATE Rewinder equipped with a "Quick-Chuck" to do your rewinding. Because the **S-100-SP** is self-powered, you can reliably use more cutting blades than on a Slitter that is powered by a Rewinder. You can add additional **BH-1 Blade Holders** for a total of five across the maximum label width of 175-mm (6.9"). The **S-100-SP** is a great choice for you label needs.

The easily replaced slitting blades are click-adjustable, maximizing their useful life. Special, very sharp, ground steel blades are supplied with the **S-100**, **S-200** and **S-100-SP** and are recommended for replacement. No tools are required for blade adjustment or replacement. During slitting, the blades are stabilized with LABELMATE's proprietary system, giving a clean cut at all speeds. Rugged, heavy-gauge welded steel construction and precision parts yield a product of the highest quality.

The S-100, S-200 & S-100-SP feature a **3-Year Parts and Labour Limited Warranty**, the longest in the industry.

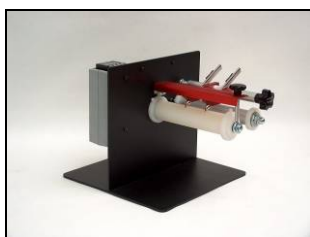

S-100 with PC-1 Counter



S-100-SP with PC-1

• INDIVIDUAL LABEL SLITTER & SLITTER ACCESSORIES •

MODEL	DESCRIPTION	LABEL WIDTH (mm)	SPEED (mm/sec)
S-100	Heavy-Duty Label Slitter. Requires a CAT-2 Rewinder. Recommended: CAT-2-CHUCK with HD-PS.	170	Same as Rewinder or printer.
S-200	Wide Heavy-Duty Label Slitter. Requires a CAT-2 Rewinder. Recommended: CAT-2-CHUCK-10" with HD-PS.	255	Same as Rewinder or printer.
S-100-SP	Self-powered Slitter Unit with 90-250VAC, 50-60Hz, 60VA Universal Power Supply.	175	300



S-100-SP

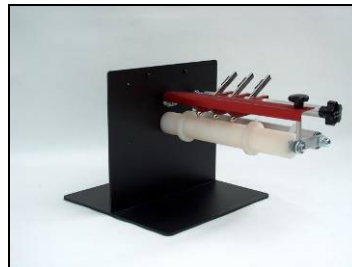

S-200



BH-1

LABEL SLITTERS S-100, S-200 & S-100-SP OPTIONS

MODEL	DESCRIPTION
PC-1	Preset counter. Counts label batch size. Stops Rewinder automatically when job is finished. Factory installed.
BH-1	Additional blade holder assembly. Includes precision high-speed blade.
HSB-10	10 precision high-speed blades for slitters.
LINK S-100	Adjustable locking bar to lock units together in position (Unwinder, Slitter & Rewinder).
LINK S-200	Same but wider.

• COMPLETE "OFF-LINE" LABEL SLITTING STATIONS •

MODEL	DESCRIPTION INCLUDES ALL YOU NEED EXCEPT LABELS & CORES	LABEL WIDTH (mm)	SPEED (mm/sec)
S-100S	<ul style="list-style-type: none"> - UCAT-S Economy Heavy-Duty Label Unwinder with fixed brake; - S-100 Heavy-Duty Label Slitter; - 2 Blade Holders with Blades; - CAT-2-CHUCK Heavy-Duty Rewinder; 76mm diameter 'Quick-Chuck' is Standard; specify if 38, 40, 44 or 70mm diameter is desired instead. - 1 Aluminium and 2 Thin Plastic Separator Plates (220mm diameter); - 'LINK': Adjustable Locking Bar to lock units together in position, - 15V Power Supply. 	170	1250
S-200S	<ul style="list-style-type: none"> - UCAT-1-10" Heavy-Duty Label Unwinder; - S-200 Heavy-Duty Label Slitter; - 3 Blade Holders with blades; - CAT-2-CHUCK-10" Heavy-Duty Rewinder; - 1 Aluminium and 3 Thin Plastic Separator Plates (220mm diameter); - 'LINK': Adjustable Locking Bar to lock units together in position; - 15V Power Supply. 	255	1250

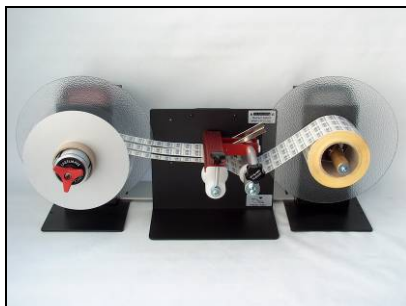

S-100S

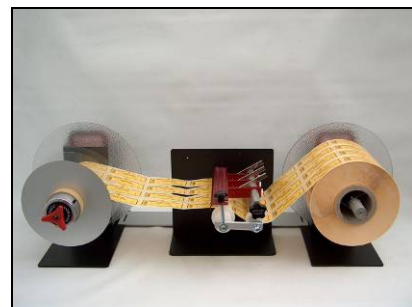

S-200S

"SP" Label Separator Plates for Slitters

Keeps slit label rolls from interleaving or telescoping. Makes removal of slit rolls easy. Aluminium separator Plates are recommended for the outer Plates, Thin Plastic for the Plates in-between slit rolls. Suggested order: 1 Aluminium Separator Plate + Plastic Plates in-between slit rolls.

• LABEL SEPARATOR PLATES FOR SLITTERS •

MODEL	ADD SUFFIX (mm)	DESCRIPTION	AVAILABLE
SP	25-220	220mm diameter for 25mm cores	Aluminium OR Plastic
	38-220	220mm diameter for 38mm cores	Aluminium OR Plastic
	40-220	220mm diameter for 40mm cores	Aluminium OR Plastic
	40-300	300mm diameter for 40mm cores	Aluminium
	44-220	220mm diameter for 44mm cores	Aluminium OR Plastic
	70-220	220mm diameter for 70mm cores	Aluminium OR Plastic
	76-220	220mm diameter for 76mm cores	Aluminium OR Plastic
	76-300	300mm diameter for 76mm cores	Aluminium
	76-400	400mm diameter for 76mm cores	Aluminium
	ACH-220	220mm diameter for Adjustable Core Holders	Aluminium OR Plastic
	ACH-300	300mm diameter for Adjustable Core Holders	Aluminium



SP-ACH

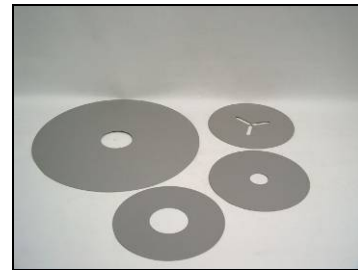

Various SP

"RRC" Reel-to-Reel Counting System

The new **RRC-330 Reel-to-Reel Counting Systems** brings you new convenience in a self-contained table-top Label Counting System using a pre-set counter. The **RRC-330** accepts rolls with a maximum size of 330mm (13"). The optional built-in encoder allows length measurement and offers direct read-out in Metric or British & American Units.

RRC-330: Accepts roll with a maximum outer diameter of 330mm. Take-up shaft is available both in Standard and Adjustable Core Holder. The **Standard** take-up shaft is available is 38, 40, 44, 70 and 76mm. The **ACH** (Adjustable Core Holder) accepts cores from 25 to 101mm. The supply core is supplied in both 40mm and 76mm (other core diameters available on-demand).

IMPORTANT NOTE: *The RRC can not be used for transparent labels.*

Designed for all-day, every-day use, the **RCC-330 Reel-to-Reel Counting Systems** is backed by LABELMATE's famous **3-Year Parts and Labor Limited Warranty**, assuring you trouble-free performance.



RRC-330-ACH

• REEL-TO-REEL COUNTING SYSTEMS •

MODEL	ADD SUFFIX	DESCRIPTION	LABEL WIDTH (mm)	ROLL DIAM. (mm)	SPEED*
RRC-330	STANDARD	Self-contained Counter System with 220-240VAC, 50-60Hz, 100VA Universal Power Supply. 40 & 76mm for the supply core and take-up shaft, (other diameters on demand).	152	330	Min.: 65cm/sec.
	ACH	Self-contained Counter System with 220-240VAC, 50-60Hz, 100VA Universal Power Supply. 40 & 76mm for the supply core. Adjustable Core Holder (25mm to 101mm) for the take-up shaft.	152	330	Min.: 65cm/sec.

* Minimum speeds are specified with a 76mm take-up roll diameter.

MAXIMUM LABEL ROLL WEIGHT: 6Kg.

RRC-330 REEL-TO-REEL COUNTING SYSTEMS OPTIONS

MODEL	DESCRIPTION
ENC	Optional built-in encoder for length measurement. Resolution: 4.4mm Direct read-out in Metric or British & American Units.
PS-24V	230V - 50Hz AC Power Supply for RRC-330. Output: 24V – 4.17A. Included with RRC-330.
NO COUNT	RRC without counter for simple reel-to-reel operations.

“COUNT” Heavy-Duty Label Counters

The **PC-1 Label Counter** is a popular option on our **S-100** and **S-200 Label Slitters**. Many times, however, users don't need to slit labels, just count them. To save users money, LABELMATE has introduced two Label Counters and Counting Stations based on the **S-100** and **S-200** Slitter chassis but without the Slitter function. The **COUNT-100** and **COUNT-200** will handle label webs up to 170 mm and 255 mm (6.5- and 10-inches) wide respectively. A **CAT-2** Rewinder pulls the labels through the counter. The versatile Counters can be used at the output of a printer, or can be used with an **UCAT Unwinder** and a **CAT-2 Rewinder** to form a stand-alone off-line label inspection / counting station.

The **COUNT-100** and **COUNT-200** Counters can count up, or count up to a preset count as you wish. If desired, when the pre-set count is reached, the **COUNT-100** and **COUNT-200** can send a “HALT” signal to the **CAT-2 Rewinder**, causing it to stop.

The counter sensor itself is a state-of-the-art infra-red transmissive device that shines through the label web and detects the gap between successive labels. There is a sensitivity control to adjust for different kinds of label webs. **Create your counting station by adding the Rewinder and Unwinder of your choice to the COUNT-100 or COUNT-200.**

IMPORTANT NOTE: The COUNT-100 and COUNT-200 can not be used for transparent labels.

The **COUNT-100** and **COUNT-200** Counters are reasonably priced saving hundreds compared to purchasing a complete Slitting Station with Counter. Quality and reliability are cornerstones of the LABELMATE Product Line. Rugged, heavy-gauge welded steel construction and precision parts yield a product of the highest quality. LABELMATE Products are trouble-free and covered by our famous **3-Year Parts and Labour Limited Warranty**.



COUNT-100

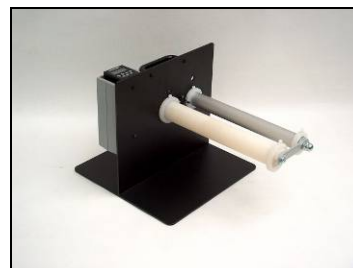

COUNT-200

MODEL	DESCRIPTION	WEB WIDTH (mm)
COUNT-100	PC-1 Preset Counter mounted on chassis with guides to position label web through sensor gap. Adjustable counter sensitivity. Counts single / multi-across labels or preset batch size. Can stop Rewinder (CAT-2) automatically when job is finished.	170
COUNT-200	Same as COUNT-100 with wider width capacity.	255

NOTE: Requires a CAT-2 Rewinder to pull your labels through the Counter. Can also be used with a Label Unwinder to form a complete off-line label counting and manual inspection station. No slitting function is included.

“PM-300” Reel-to-Reel Label Printer Mechanism For Inkjet Heads

Meet the new PM-300 Reel-to-Reel Printer Mechanism from LABELMATE. At speeds up to 220cm/sec, you can conveniently and economically print or overprint labels using your preferred inkjet head. With full status indicators and control features, the PM-300 is an ideal table top platform for OEM applications that use an inkjet head. When not used as a printer, the PM-300 can be used as a reel-to-reel Counter – Rewinder. The built-in encoder has a resolution of 0,041mm.

The PM-300 comes in two versions, the PM-300-LS and the PM-300-HS. The PM-300-LS will print a 28cm diameter roll (425 meters) of labels in less than 7 minutes; the PM-300-HS will print the same roll in less than 5 minutes. The model choice is dictated by the performance of the inkjet head being used.

Designed for all-day, every-day use, the PM-300 Reel-to-Reel Printer Mechanism is backed by LABELMATE’s famous **3-Year Parts and Labour Limited Warranty**, assuring you trouble-free performance.

KEY FEATURES

- **Resolution:** 0,041mm.
- **Maximum roll diameter:** 300mm.
- **Max. roll weight:** 6Kg.
- **Label width:** up to 115mm.
- **Speeds:**
LS-Version: Max. 150cm/sec. For a roll of 28cm diameter and a core of 76mm.
E.g.: 7 min. for a roll of 28cm diameter with a 76mm core at full speed. Average speed: 100cm/sec.
HS-Version: Max. 220cm/sec. For a roll of 28cm diameter and a core of 76mm.
E.g.: 4,5 min. for a roll of 28cm diameter with a 76mm core at full speed. Average speed: 150cm/sec.

KEY FEATURES (cont.)

- Rugged Construction.
- Secured DB-9 Print Head Connector.
- Adjustable Label Guide.
- 90-240V – 50-60Hz AC Input.
- Encoder Output: Square waves: 0 - 15V.
- Label sensor: Open collector output.

OPTIONS

- **PC-2:** Optional 6-digit pre-set counter.
- **BC:** Mounting bracket and cable for print head.
- **CUST.:** Customised version.

CONTROLS

- Start / Stop
- Counter Reset
- Speed Control



STATUS INDICATORS

- Power On – Green
- Error / Stop – Red
- Head Error – Red
- Label Gap – Orange

PM-300

September 2009

www.labelmate.com

brussels@labelmate.com

• REEL-TO-REEL PRINTER MECHANISM •

MODEL	DESCRIPTION	LABEL WIDTH (mm)	ROLL DIAM. (mm)	MAX. SPEED
PM-300-LS	Reel-to-Reel Printer Mechanism.	115	300	150m/sec.*
PM-300-HS	Reel-to-Reel Printer Mechanism. High-speed version.	115	300	220cm/sec. *

* **Maximum speeds are specified with a 76mm take-up roll diameter.**

E.g.: With the PM-300-HS 4.5 min. for a roll of 28cm diameter with a 76mm core at full speed.
Average speed: 1.5m/sec.

MAXIMUM LABEL ROLL WEIGHT: 6Kg.

PM-300 REEL-TO-REEL PRINTER MECHANISM OPTIONS

MODEL	DESCRIPTION
PC-2	Preset counter. Counts label batch size. Stops Rewinder automatically when job is finished. Factory installed.
HSA™-BC	Mounting bracket and cable for HSA™ printhead.
BC	Mounting bracket and cable for other printhead.
PS-24V	230V - 50Hz AC Power Supply for PM-300. Output: 24V – 4.17A. Included with PM-300.